

PRODUCT CATALOG
**DISPOSABLE FACE MASKS
OF RUSSIAN MANUFACTURE**

2020

DISPOSABLE FACE MASKS OF RUSSIAN MANUFACTURE



Disposable application

Synthetic non-woven fabrics used in production are specially designed for healthcare products.



Output rate

The total production capacity of mask manufacturers in the Russian Federation is up to 10 mio. masks a day.



Quality

Hypoallergenic materials with high air permeability which do not irritate facial skin are used in products. All product models are tested in laboratories.



Delivery

Products are exported from international Russian airports, which ensures the shortest time of delivery.

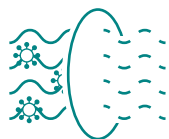

Meltblown

All masks of Russian manufacture contain filtering material with the fiber spacing smaller than the size of most viruses and bacteria, including coronavirus.

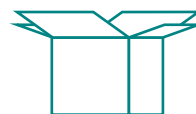

Packaging

Manufacturers offer various consumer packages which differ, among other things, in colors, materials and number of units.



Sterility

Masks may be additionally sterilized to be used by healthcare providers.



Color

Various color choices are available for the products – both single-color masks and masks with custom design (printing).

A line drawing of a person's face wearing a grey surgical-style face mask. The mask has a white nose clip at the top and two teal elastic ear loops. A dashed teal line outlines a rectangular area on the front of the mask, which is highlighted with a light blue shaded area. Three callout lines with small white circles at the end point to the nose clip, the filter area, and one of the ear loops. The background consists of light grey wavy lines.

Nose clips

made from durable, flexible materials for tight fit

Filter layer

filtration level up to 99 %

Elastic ear loops

Made from elastic and soft material for additional comfort

CONZERN ZNAK



Price

\$ 0,31¹⁵

€ 0,27⁹⁸

Material

SMS

Thickness

75 g/m²

Size



170

Color



Certified

ISO

ISO 9001:2015

Retail packing



Order Option

Min. amount

5 000

100% prepayment

Discounting

Base price if the order quantity is 5,000 pcs.

| | |
|-------------|------|
| > 10 000 | 5 % |
| > 50 000 | 9 % |
| > 250 000 | 14 % |
| > 1 000 000 | 18 % |

Producer

| | |
|------|--------------------|
| Name | LTD "Konzern Znak" |
| TIN | 5904001222 |
| City | Moscow |

Contacts

| | | |
|-----------|-----------------------------|---|
| Name | Alexandr Nikiforov |  |
| E-mail | nikiforov@cznak.ru | |
| Telephone | +7 495 925 31 99 (ext. 315) | |

Polyethylene pack

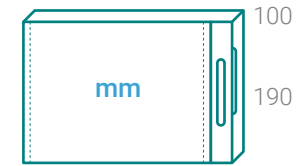

220



gross net

220 200



100 units

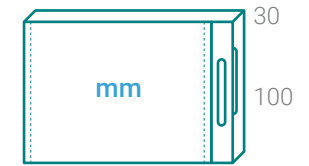

200



gross net

25 20



10 units

Options



EVTEX



Retail packing



Polyethylene pack

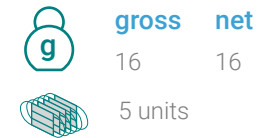
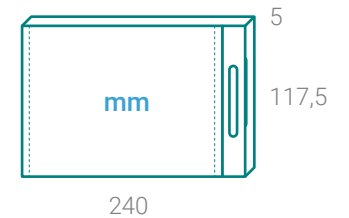
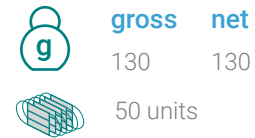
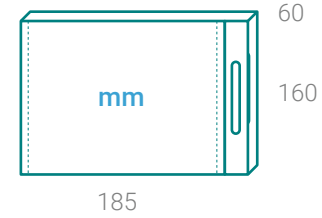

Price

\$ 0,21⁰⁰

-

Sterility

no

Material

SSMSS

Thickness

60 g/m2

Size

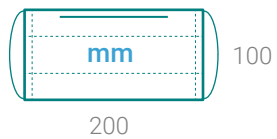

Color



Order Option

Min. amount
50 000

100% prepayment

Polyethylene pack



Certified

ISO

ISO 13485:2016

Producer

Name LLC "Evtex"

TIN 7743935342

Address Moscow

Contacts

Name Elizaveta Borodina

E-mail evers@evers.ru

Telephone +7 916 751 27 58



GEXA-NONWOVEN MATERIALS



Retail packing



Carton box

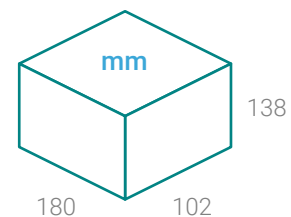

gross 325 g
net 300 g

100 units

Polyethylene pack

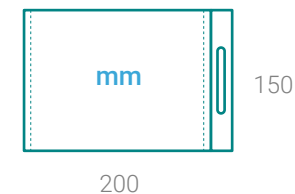

gross 40 g
net 37,5 g

10 units

Price

\$ 0,18⁸⁰

€ 0,21⁴⁰

Sterility

yes

Material

SMS

Thickness

58 g/m²

Order Option

Min. amount
2 000 000

100% prepayment

Shipment

Order to be placed 30 days
before shipping

Certified

ISO

ISO 13485:2016; ISO 9001:2015

Producer

Name LLC "Gexa-nonwoven materials"
TIN 7714132189
City Krasnogorsk

Contacts

Name Nevert Elena
E-mail info@maska-resid.ru
Telephone +7-963-611-28-36



Options



KARO



Price

\$ 0,14⁰⁸

€ 0,12⁸²

Sterility

Material

Thickness

upon request

SMS

55 g/m2

Size

Color



200



Certified

RU.PX01.H00609, 20

Retail packing



Discounting

Discounting terms and conditions are discussed on a case-by-case basis.

Order Option

Min. amount

100 000

100% prepayment

Producer

Name LLC "Karo"

TIN 4025427560

Zip-lock (polyethylene)

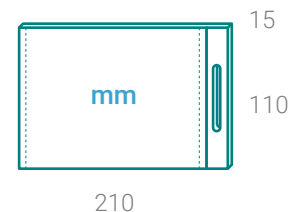

210

15
110



gross net

36 30



10 units

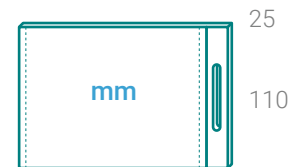

210

25
110



gross net

66 60



20 units

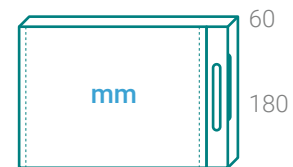

210

60
180



gross net

148 140



50 units

Contacts

Name Eugeniy Mahtey

E-mail med@karo-group.ru

Telephone +7 963 679 44 06

Address Kaluga Region,
Borovsky District,
village of Kabitsyno

LEO



Price

\$ 0,14⁰⁰

€ 0,12⁰⁰

Material

SMS

Thickness

75 g/m²

Size



175

Color



Producer

Name LLC "Company"
TIN 5073004158
City Orekhovo-Zuevo

Retail packing



Cardboard

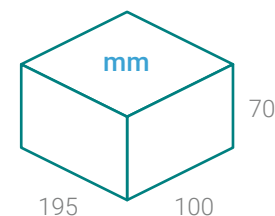

g gross net
175 152

 40 units

Polyethylene pack



g gross net
158 152

 50 units

Order Option

Min. amount
500 000

50 % prepayment

50% before shipping

Discounting

> 4 mln 10 %

> 5.5 mln 15 %

> 7.5 mln 20 %

Delivery

The production capacity is 10 mln pieces a month. The date of readiness for shipment depends on the package. In case of standard packaging, a lot of 500 000 masks can be shipped on the day following the day of receipt of the payment.

Contacts

Name Nevert Elena
E-mail info@maska-resid.ru
Telephone +7-963-611-28-36



NEWFARM



Price

\$ 0,26⁷⁶

€ 0,24³⁵

Material

SMS / SSMSS

Thickness

75 g/m²

Size



175

Color



Certified

ISO

ISO 13485-2017

Retail packing



Discounting

If more than 1 000 000 pieces is shipped

Order Option

Min. amount
400 000

30% - prepayment

70% - before shipping

Producer

Name LLC "NEWFARM"

TIN 3703015180

City Kineshma

Euro hook hanging pouch

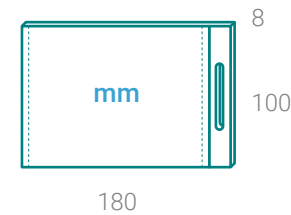

180

8



gross net

— —



3 units



180

10



gross net

— —



5 units

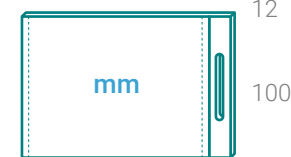

180

12



gross net

— —



10 units

Blister pack

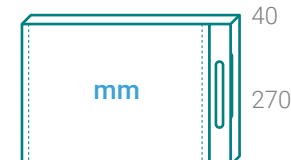

300

40



gross net

— —



50 units

Contacts

Name Perova Marina

E-mail marinaperova1311@n-farm.ru

Telephone +7 910 696 30 22



PHARMSERVICE



Price

\$ 0,23⁹⁴

€ 0,21⁷⁹

Material

SMS

Thickness

75 g/m²

Size



150

Color



Certified



ISO 9001:2015



in the process

Retail packing



Order Option

Min. amount

10 000

100% prepayment
or partial prepayment
(individually discussed)

Producer

Name LLC "PharmService"

TIN 2312178145

City Krasnodar

Discounting

Discounts are granted
depending on the quantity
purchased and the terms
of payment.

Contacts

Name Victoria Kainova

E-mail v.kainova@phsv.ru

Telephone +7 918 039 96 43



BOPP film

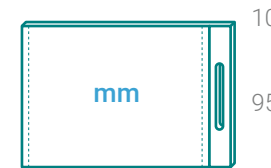

295

10

95



gross net

15 15



5 units



295

20

95



gross net

30 30



10 units

Polyethylene pack



210

80

130



gross net

152 148



50 units

Delivery

If necessary, the capacity of factory-supplied
boxes can be changed according to the
customer's requirements.

REABILITIK



Retail packing



Carton box

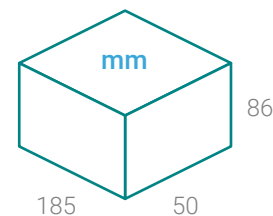

gross net
g 109,8 87

100 units

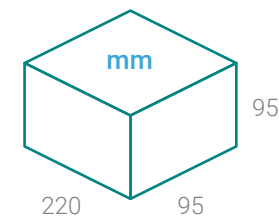

gross net
g 183 145

100 units

Price

\$ 0,21¹³

€ 0,19²³

Sterility

upon request

Material

SMS

Thickness

60 g/m2

Size



Color



Order Option

Min. amount
50 000

100% prepayment

Discounting

Flexible discount system
as agreed with the purchaser

Producer

Name LLC "Reabilitik"
TIN 7719867677
City St. Petersburg

Contacts

Name Alexeev Sergey
E-mail assist@rebq.ru
Telephone +7 911 830 20 59



Polyethylene pack

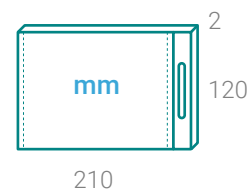

gross net
g 5 3

1 unit

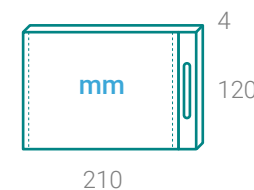

gross net
g 11 9

3 units

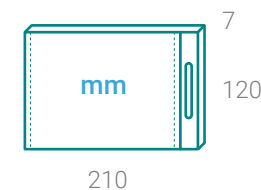

gross net
g 17 15

5 units

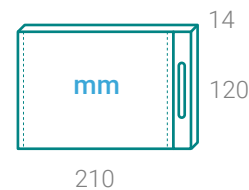

gross net
g 31 29

10 units

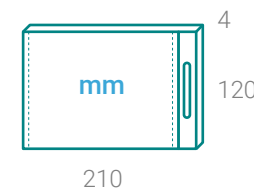

gross net
g 90 87

30 units

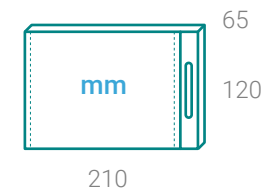

gross net
g 149 145

50 units

RESID



Retail packing



Polyethylene pack

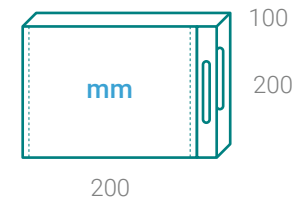

g gross net
232 230

 100 units

Price

\$ 0,30⁰⁰

€ 0,27⁰⁰

Sterility

no

Material

SMS

Thickness

52 g/m²

Size

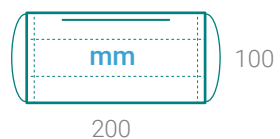

Color



Order Option

Min. amount

300 000

100% prepayment

Delivery

Delivery as per the tariffs of the Transport Companies at the Purchaser's expense

Producer

Name LLC "Resid"

TIN 7708804509

Address Chelyabinsk



Options

Certified

ISO

ISO 13485:2003

Contacts

Name Nevert Elena

E-mail info@maska-resid.ru

Telephone +7-963-611-28-36



TREK



Retail packing



Polyethylene pack

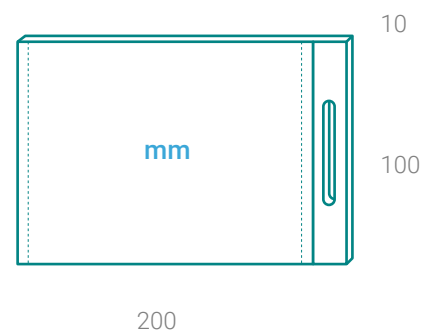

gross **net**

20 18

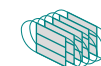

5 units

Price

\$ 1,00⁰⁰

€ 0,91⁰⁰

Sterility

yes

Material

SMS

Thickness

75 g/m²

Size



175

Color



Order Option

Min. amount
100 000

30 % prepayment –
when concluding a contract

70 % payment –
before shipping

100 % prepayment –
if the order quantity
is 1 mln units or more,

Options



Shipment Option

We will make all customs clearance at the Russian side.

Producer

Name LLC "Trek"
TIN 5908055363
Address Perm City

Contacts

Name Dementieva Natalya
E-mail dementieva@avtsport.ru
Telephone +7 922 312 63 41



2 FC



Retail packing



Price \$ 0,13⁰⁰ € 0,12⁰⁰

Material SSSMS

Thickness 75 g/m2

Size



175

Color



Producer contacts

Name LLC "Evtex"

TIN 7743935342

City Moscow

Name Elizaveta Borodina

E-mail evers@evers.ru

Telephone +7 916 751 27 58



LDPE



450

gross net
130 130

50 units

Polyethylene pack



240

gross net
16 16

5 units

Order Option

Min. amount
2 600

100 % prepayment

LOKOMOTIV



Retail packing

Price \$ 0,20⁰⁰ € 0,19⁰⁰

Material SMS

Thickness 25 g/m2

Certified **ISO** **CE** in progress

Size



175

Color



Producer contacts

Name "Lokomotiv"

TIN -

City -

Name -

E-mail -

Telephone -

Polyethylene pack

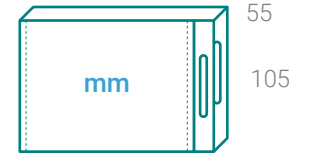

215

gross net
110 107

50 units

Order Option

Min. amount

50 000

100 % prepayment
or partial prepayment
(individually discussed)



FS PRINT



Retail packing

| | | |
|--------------|-----------------------|---|
| Price | \$ 0,21 ⁰⁰ | - |
|--------------|-----------------------|---|

| | |
|-----------------|-------|
| Material | SSMSS |
|-----------------|-------|

| | |
|------------------|---------|
| Thickness | 60 g/m2 |
|------------------|---------|

| | | |
|------------------|------------|----------------|
| Certified | ISO | ISO 13485:2016 |
|------------------|------------|----------------|

Polyethylene pack

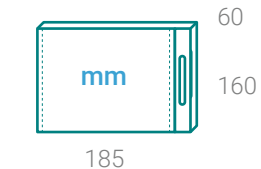

| | | |
|----------|--------------|------------|
| g | gross | net |
| | 130 | 130 |
| | 50 units | |

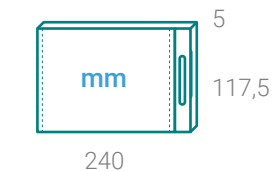

| | | |
|----------|--------------|------------|
| g | gross | net |
| | 16 | 16 |
| | 5 units | |

PARUS ELECTRO



Retail packing

| | | |
|--------------|-----------------------|---|
| Price | \$ 0,21 ⁰⁰ | - |
|--------------|-----------------------|---|

| | |
|-----------------|-------|
| Material | SSMSS |
|-----------------|-------|

| | |
|------------------|---------|
| Thickness | 60 g/m2 |
|------------------|---------|

| | | |
|------------------|------------|----------------|
| Certified | ISO | ISO 13485:2016 |
|------------------|------------|----------------|

Polyethylene pack

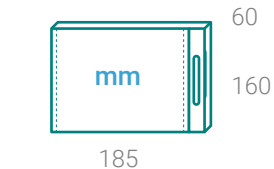

| | | |
|----------|--------------|------------|
| g | gross | net |
| | 130 | 130 |
| | 50 units | |

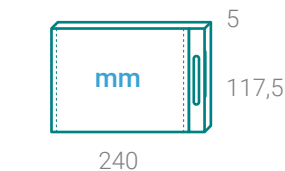

| | | |
|----------|--------------|------------|
| g | gross | net |
| | 16 | 16 |
| | 5 units | |

Size 100
200

Color

Order Option

Min. amount
50 000

100 % prepayment

Size 100
200

Color

Order Option

Min. amount
50 000

100 % prepayment

Producer contacts

| | | | | |
|-------------|----------------|------------------|--------------------|--|
| Name | LLC "FS Print" | Name | Elizaveta Borodina | |
| TIN | 7743935342 | E-mail | evers@evers.ru | |
| City | Moscow | Telephone | +7 916 751 27 58 | |

Producer contacts

| | | | | |
|-------------|----------------|------------------|--------------------|--|
| Name | LLC "FS Print" | Name | Elizaveta Borodina | |
| TIN | 7743935342 | E-mail | evers@evers.ru | |
| City | Moscow | Telephone | +7 916 751 27 58 | |

VOLGA MEDICAL



Polyethylene pack

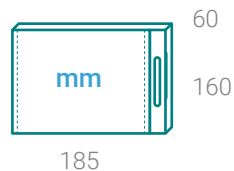

g gross net
130 130

50 units

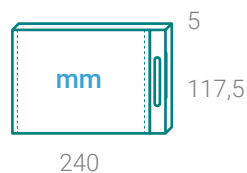

g gross net
16 16

5 units

Price \$ 0,21⁰⁰ -

Material SSMSS

Thickness 60 g/m²

Certified **ISO** ISO 13485:2016

Size



Color



Order Option

Min. amount
50 000

100 % prepayment

Producer contacts

Name LLC "FS Print"

TIN 7743935342

City Moscow

Name Elizaveta Borodina

E-mail evers@evers.ru

Telephone +7 916 751 27 58



PHARMMEDPOLIS RT



Retail packing



Polyethylene pack

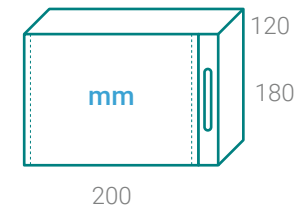

g gross net
210 200

50 units

Price \$ 0,29⁵⁷ € 0,26⁹²

Material SMS

Thickness 20 g/m²

Size



Color



Order Option

Min. amount
1 000 000

100 % prepayment

Producer contacts

Name LLC "PharmMedPolis RT"

TIN 1660313668

City Kazan

Name Dementieva Natalya

E-mail rs@pharmmedpolis.com

Telephone +7 905 377 17 71

